

# Magnetic field behavior of HV and LV systems for the LHC experiments

L. Periale, B. Allongue

EP-ESS CERN, 1211 Geneva 23, Switzerland  
Luciano.Periale@cern.ch

## *Abstract*

We present measurements made of the performance of prototype high voltage (HV) and low voltage (LV) power supplies when operated in a static magnetic field. Particular attention is paid to the test methods used and to the effect of different orientations of the devices in the magnetic field. The efficiency and reliability of the systems for use in the LHC experiments was analyzed.

## I. INTRODUCTION

The LHC experiments require electronic equipment that continues to function correctly in abnormally hostile conditions. For example, some of the devices we discuss in this paper must withstand:

- a) static magnetic fields of up to 8 kG,
- b) a radiation exposure of 1 krad TID, and  $10^{12}$  neutrons/cm<sup>2</sup> integrated over ten years.

Equipment developed for use in these conditions must undergo detailed and rigorous functionality tests in order to prove its ability to operate reliably when exposed to magnetic fields and radiation.

While developing equipment that meets these challenges it is important to separate the different aspects of the problem, while not forgetting that finally the equipment will be exposed simultaneously to all perturbing influences.

In this paper, we describe some aspects of the developments done by CAEN, [1] and WIENER, [2] to develop high and low voltage power supplies and DC-DC converters that function in the hostile conditions found close to the LHC experiments. In particular we consider the performance of the power supplies when functioning in an externally applied static magnetic field.

The key issue with the use of power supplies in static magnetic fields is the saturation of the transformers and filters. Broadly, two approaches have been adopted to resolve this problem. CAEN has followed a program of R&D to identify materials which have a high permeability and then constructed a power supply of novel design around components built with these materials. WIENER

have taken an existing power supply product and shielded the sensitive components with standard materials.

It should be understood that these two developments are not intended to satisfy the same set of requirements. The WIENER development is intended to function in fields up to 1kG, sufficient for most applications not too close to the detector. The CAEN development, however, aims to satisfy the very demanding requirements of the ALICE-TOF where DC-DC converters will be placed inside the main toroid, hence the value of 8kG quoted above. Between these two, certain locations close to the CMS detector may have fields close to 2kG.

Of utmost importance in this work is the precision measurement of the external magnetic field in which we place the devices. In this context, the collaboration of the National Institute Electro Technical "G. Ferraris" of Turin (Italy) has to be underlined. The IEN-GF specializes in providing references and certifications in this domain, and put at our disposal their laboratories for the calibration of the probes with which we have mapped the CERN magnets used to test the prototypes. Additionally, several CERN Groups [3] have provided us with access to their magnets and helped us to measure the magnetic fields efficiently.

In the following we discuss the basic concepts of the two developments, and present the characteristics that we measure when operating them in various configurations.

Systematic studies aimed at understanding and improving the radiation tolerance of these devices are also in progress, but not covered in this report.

## II. USE OF NOVEL TECHNIQUES – CAEN

### *A. Strategy*

CAEN adopted a novel research strategy leading to the development of an innovative series of LV and HV devices suitable for use in magnetic fields.

The initial step was the construction of transformers able to operate in high external fields. Numerous types of toroidal components built with high permeability (i.e. saturating at high magnetic field strength) ceramics were investigated. Moreover, the choice of the toroidal devices is closely tied

to the characteristics of the wires with which the windings are made. Coils with the desired inductance values were constructed, and detailed tests performed to verify their behaviour in static magnetic fields in the range from zero up to 10kG.

After the development of suitable coils, the development of the surrounding circuitry was done. As will be discussed later, the circuitry required differed from that of a “standard” power supply. Finally the monitoring and control hardware was developed resulting in the system configuration shown in figure 1, [3].

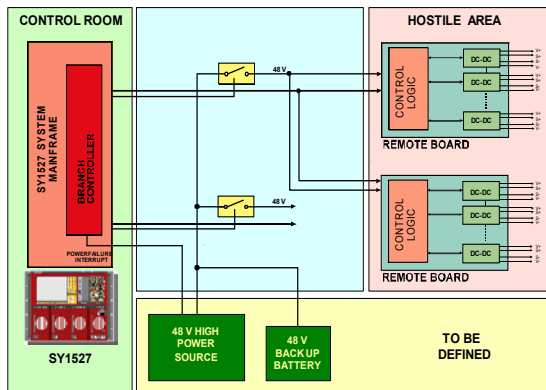

Figure 1 CAEN system concept.

### B. Initial measurements and results

A number of groups at CERN have magnets that are readily made available on request. These magnets come in various dimensions and strengths, some able to provide up to 3T. In order to have the best precision possible Hall probes, suitably calibrated at IEN-GF of Turin, were used to make maps of the fields within the magnets used. Figures 2 and 3 show a photograph and block diagram of the test set-up.

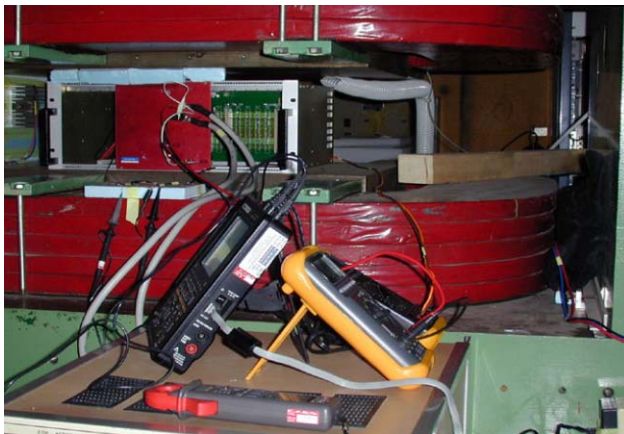

Figure 2 Photograph of classic set-up.

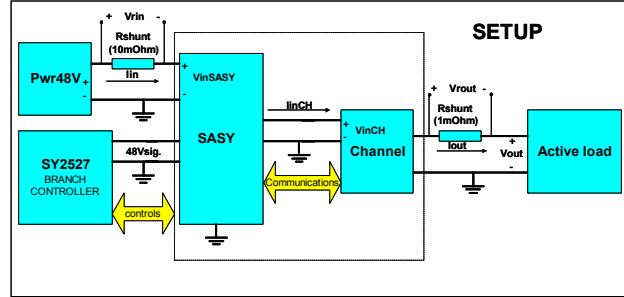

Figure 3 Block diagram of test system.

The final results obtained for the efficiency of a single channel of the SA2004 and SA200X devices are shown in figures 4, 5, and 6. As discussed in the following section, this performance was possible only after a key modification to the driving circuitry was made.

<b>Vin</b>	<b>45.5 V, 48 V, 50.5 V</b>
<b>Vout</b>	<b>5 V</b>
<b>Iout</b>	<b>30, 40, 50 A</b>
<b>B</b>	<b>0, 1, 3, 5 kG</b>

Table 1: Conditions for the determination of the channel efficiency of the SA2004 (see figure 4).

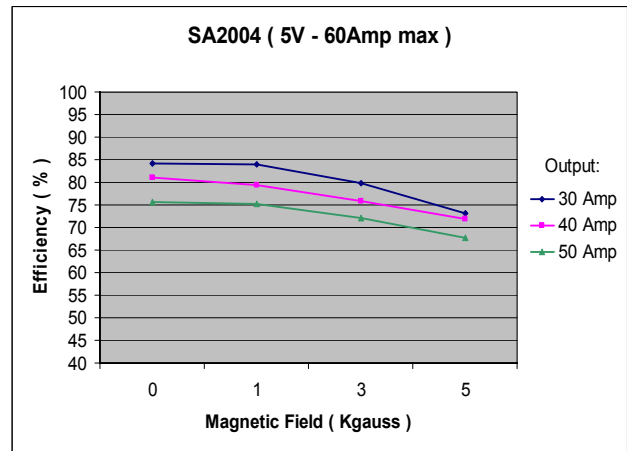

Figure 4 Test result for a single SA2004 channel.

<b>Vout</b>	<b>5 V</b>
<b>Iout</b>	<b>40, 60, 80 A</b>
<b>B // and ⊥</b>	<b>0, 1, 2, 3, 4, 5 kG</b>

Table 2: Conditions for the determination of the channel efficiency of the SA200X (see figures 5 and 6).

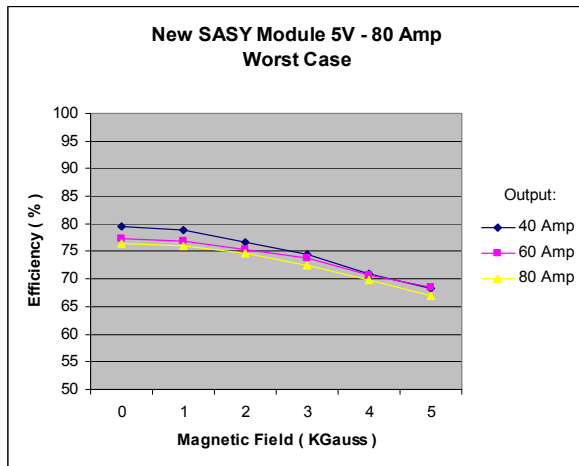

Figure 5 Test results for a SA200X module in the “worst case” orientation.

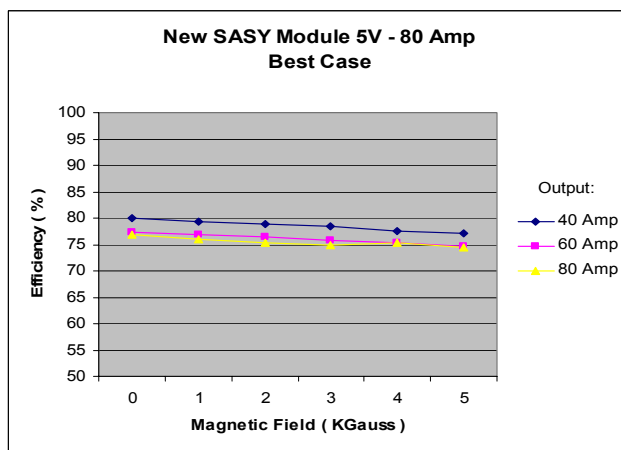

Figure 6 Test results for a SA200X module in the “best case” orientation.

The orientation of the magnetic field with respect to the toroidal coils affect its behaviour significantly, resulting in the “worst case” and “best case” performances of figures 5 and 6.

After having obtained satisfactory configurations, the entire design was patented. This represents one of most important results of the R&D carried out by CAEN for the LV and HV Power Supplies, [4].

### C. Problem found and solved

During the early development of the device it was discovered that, though able to withstand high magnetic fields, the output current was severely limited. The problem was traced to an asymmetry in the currents drawn in the transformer’s primary circuit on odd and even switches (see Figures 7, 8, and 9).

In order to remedy this an original redesign was needed for the primary circuit. The waveforms of the transformer’s primary circuit after the circuit had been modified to balance the currents are shown in figures 10, 11, and 12.

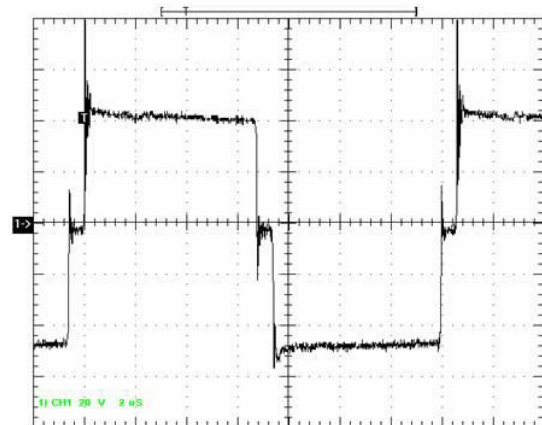

Figure 7 Primary voltage (original circuit).

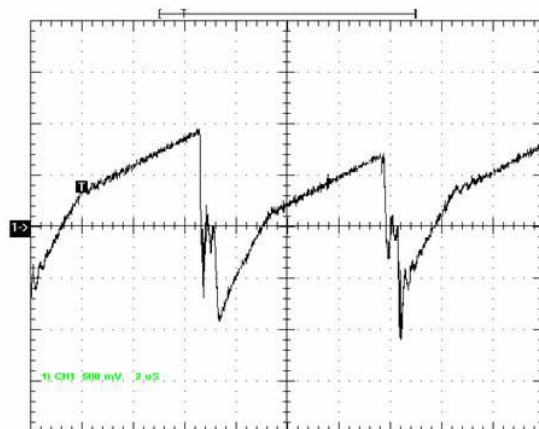

Figure 8 Primary current at 2kG (original circuit).

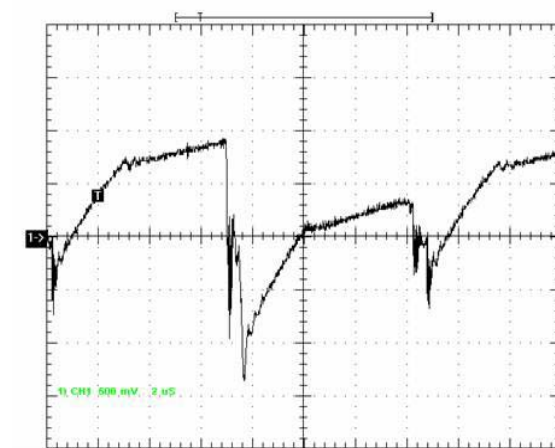

Figure 9 Primary current at 5kG (original circuit).

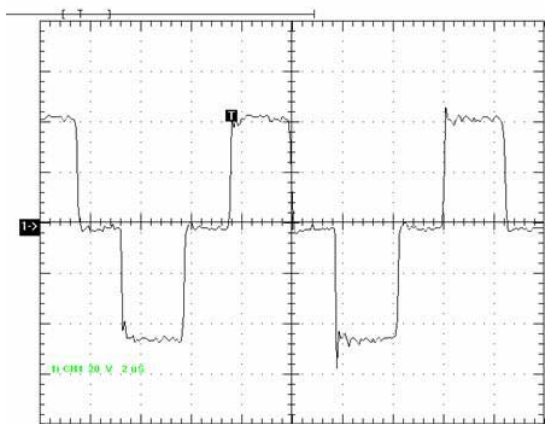

Figure 10 Primary voltage (modified circuit).

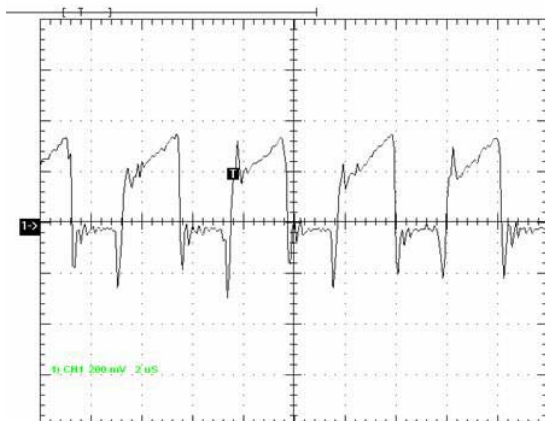

Figure 11 Primary current at 2kG (modified circuit).

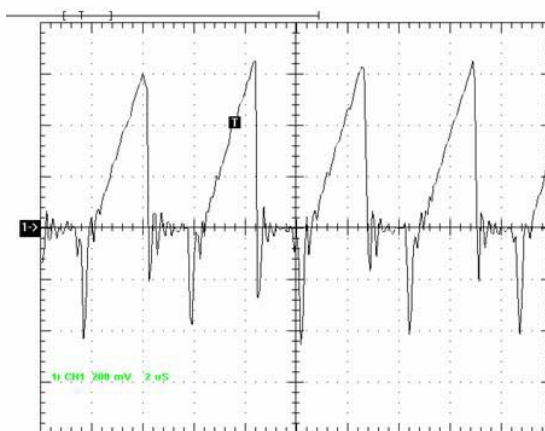

Figure 12 Primary current at 5kG (modified circuit).

#### D. Extended measurements

During the months of July and August 2003, the ALICE TOF Group performed an extended series of tests over a period of forty days. They used the CMS-MNP22 test magnet (see figure 13) on the Preveessin site, with a magnetic field map produced by L. P. shows in figure 14. Figure 15 shows the instrumentation used to perform the tests.



Figure 13 CMS-MNP2 magnet.

Magnetic field (mT) vs solenoid current (A)

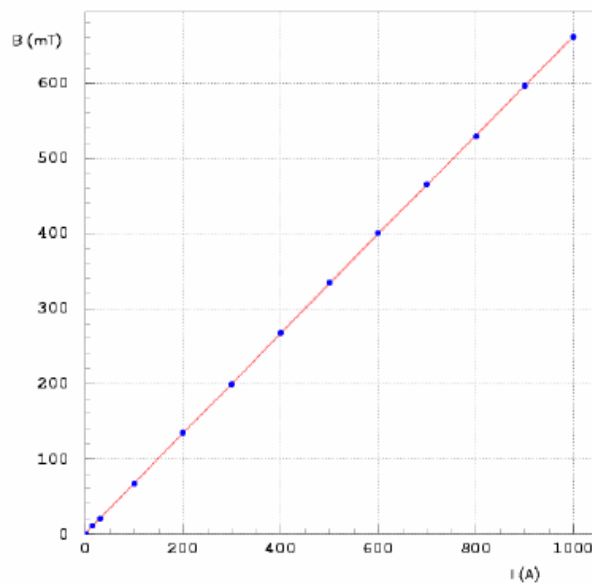

Figure 14 Calibration of the magnetic field strength using a Hall probe provided by IEN.



Measurements were performed continuously during the whole period, with just short interruptions to change passive and active loading conditions. Additionally start-ups and rapid shutdowns were performed so as to stress the system and discover possible deficiencies or defects in the power supply modules or distributors.

The results of the tests are shown in figures 16 to 20 for values of the magnetic field strength from 0 up to 5kG [5].



Figure 15 Device under test in the CMS-MNP2 magnet.

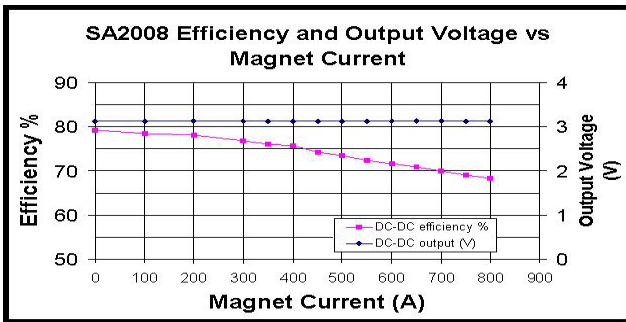

Figure 16 SA2008 module efficiency.

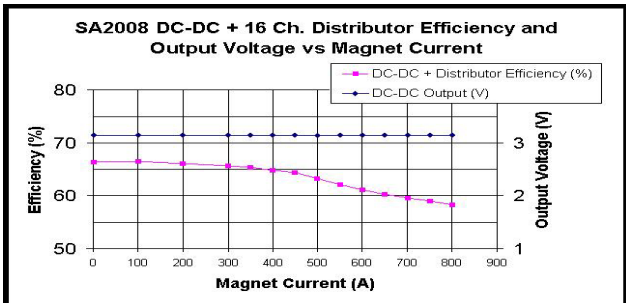

Figure 17 SA2008 DC-DC + 16 Channels. Distributor efficiency.

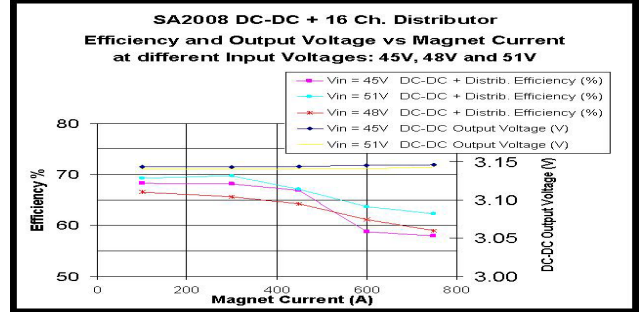

Figure 18 SA2008 DC-DC + 16 Channels. Distributor at different input voltages.

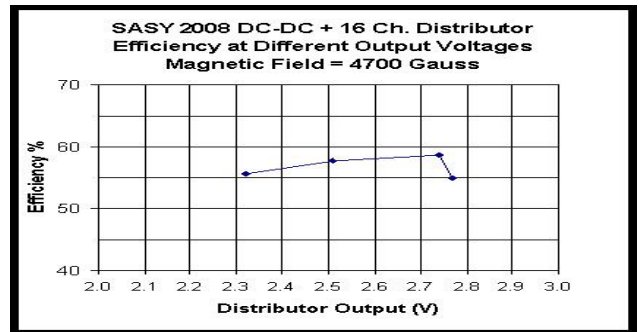

Figure 19 SA2008 DC-DC + 16 Channels. Distributor at different output voltages.

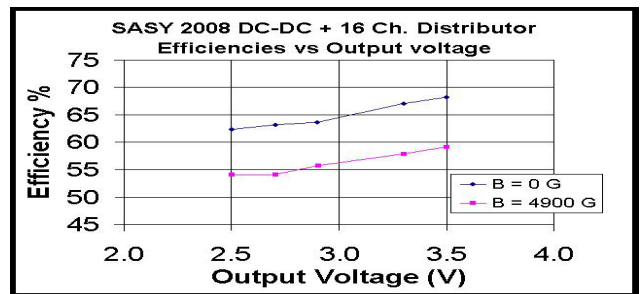

Figure 20 SA2008 DC-DC + 16 Channels. Distributor vs. output voltage.

### III. APPROACH USING STANDARD COMPONENTS-WIENER

The approach of WIENER is to start with one of their existing low voltage power supply products and to make the minimum modification necessary in order that it functions correctly in the LHC environment; with regards magnetic field tolerance, the unit should work in field strengths up to 1kG.

Following tests performed within in the ESS group at CERN, an enclosure of 5mm thick soft iron was used to

shield those components whose performance was expected to degrade in a magnetic field.

Initial tests were performed in the ESS test magnet (see figure 21), however, due to the limited aperture of the magnet the clearance between the device under test and the magnet yoke was minimal thus rendering a reliable measure of the magnetic field strength very difficult. For this reason all of the measurements were repeated in the CMS-MNP2 magnet, and it is these measurements that we report here.



Figure 21 ESS test magnet (capable of 1.8kG).

### E. Magnetic shielding of the power module

Figure 22 is a schematic of the power module under test: a 300kHz DC/DC converter with 325V DC input and 15V DC / 20A output. In the WIENER low voltage power supply, the 325V DC is produced by a separate AC/DC module powered from the mains. Since these tests focus on the performance of the power module, a standard DC power supply was used in place of the AC/DC module.

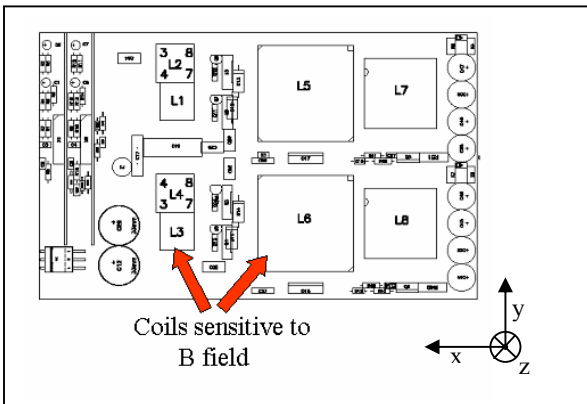

Figure 22 Power module schematic.

The components most susceptible to a magnetic field are the transformer of the switching circuit and the input and output filter transformers, indicated in figure 22.

These have been enclosed within 5mm thick soft iron. The shielding is clearly visible in the photograph shown in figure 23.



Figure 23 Photograph of the power module.

### F. Measurements

The test set-up is shown in figure 24. The input to the power module is supplied by a standard DC power supply. The output is connected to an electronic load which allows a current to be drawn from the power module to be adjusted.

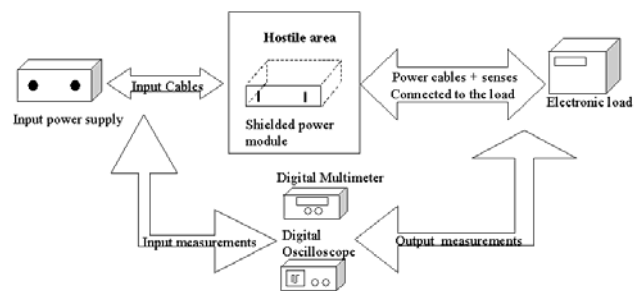

Figure 24 Test system.

For a given load (10A, 20A) the input current, output voltage and output ripple are measured as a function of magnetic field strength in steps of 50 Gauss. Since the

orientation of the magnetic field with respect to the coils will change the behaviour of the module all measurements are performed in three orthogonal orientations. This is done by orienting the module within the magnetic such that the field lines lie along the axes shown in figure 22.

### G. Results

The variations of the measured parameters with magnetic field are shown in figures 25, 26, and 27 for the three orientations. In the best case orientation (figure 27), with the field along the z-axis of the module, there is no observed degradation in the performance of the module up to 1.5kG. In the other two orientations the module is unaffected by the magnetic field up to approximately 1.1kG, after which it quickly ceases to function.

These tests demonstrate that the power module may be made to function in fields up to 1kG simply by shielding the sensitive components.

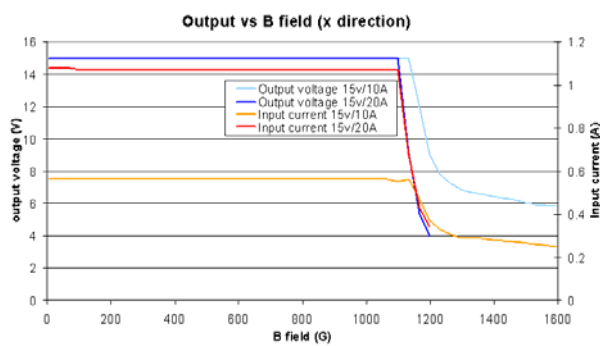

Figure 25 Field oriented along x.

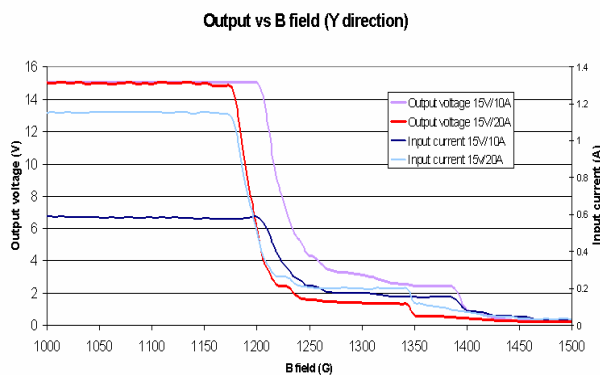

Figure 26 Field oriented along y.

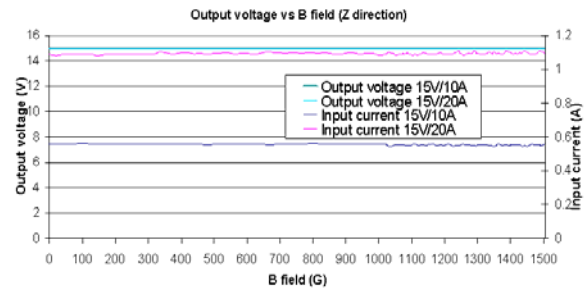

Figure 27 Field oriented along z.

## IV. CONCLUSIONS

We have investigated the use of LV and HV power supplies in a magnetic field using two particular solutions:

- 1) A solution from CAEN that uses innovative technology to withstand elevated magnetic fields of the order of 10kG [6, 7].
- 2) An approach by WIENER based on shielding those components particularly sensitive to the magnetic field. This device is fully functional up to 1kG.

Further efficiency and stability tests in elevated magnetic fields are foreseen.

## V. ACKNOWLEDGEMENTS

We would like to acknowledge all our colleagues of the Materials Department at IEN-GF of Turin. We are deeply indebted to Franco Vinai for his friendly and invaluable scientific contributions.

We thank G. Passuello, C. Raffo, C. Landi, S. Petrucci, S. Selmi, G. Selmi, of the CAEN S.p.A for their essential work and discussions during all tests.

Special thanks to F. Cindolo, S. DePasquale, S. Sellito of the ALICE-TOF for their constant support and scientific contributions.

Finally we would like to thank Andreas Koester for his help and support during the test campaign of the WIENER system.

## VI. REFERENCES

- [1] CAEN S.p.A. Via Vetraria 11- 55049 Viareggio - Italy.
- [2] WIENER - Plein & Baus GmbH, D-51399 Burscheid (Germany) Mullersbaum 20.
- [3] ATLAS, CMS, EP/TA3.
- [4] J. Givoletti - Tesi di Ingegneria: "Sistema remoto per il controllo e la gestione di canali LV e HV in ambiente ostile"- Univ. di Siena, I - 2001/2002.
- [5] Preprint INFN/Bo-Sa - 15/09/2003.
- [6] G. Grieco LECC- 2001 Stockholm - SE
- [7] N. Paoli LECC- 2002 Colmar - F