

Effects of CM and DM noise propagation in LV distribution cables.

F. Arteché*, C. Rivetta**

*CERN, 1211 Geneva 23 Switzerland, ** FERMILAB, P.O. Box 500 MS341, Batavia IL 60510 USA,
(Principal contacts: fernando.artech@cern.ch rivetta@fnal.gov)

Abstract

The CMS detector is supplied by thousand power supply units located either in the counting room or in the periphery of the detector. The front-end electronics and the power supply units are connected through long power cables that propagate the output noise from the power supplies to the detector. This paper addresses the effect of these long cables on the noise propagation and the impact that those cables have in the selection of EMI filters for the FEE low-voltage input and conducted emission levels required for the power supplies. This analysis is part of the EMC-based design approach to define the type of cable (shielded or unshielded), shield connections, filters and power supply specifications required to ensure the good performance of the FEE

I. INTRODUCTION

The electronics read-out of the CMS detector processes and digitises the signals collected after a physics interaction and transmits the processed signals to the counting room by optical links. The front-end electronics (FEE) of any CMS sub-detector can be considered as an isolated system with the only external electrical connection made by the low-voltage and high-voltage power supply system. Power supply units for the CMS detector will be placed in two areas, the periphery of the detector, distant about 20 meters from the front-end electronics and in the counting room about 120 meters away from the FEE due to the harsh environment inside the detector.

The understanding of the effect of long shielded power cables in the noise propagation and its interaction with the FEE becomes an important issue to define FEE immunity levels and the conducted noise emission levels required for the power supplies. In addition, near and far electromagnetic fields induce currents in the cable shields that interfere with the system if those currents are coupled to the conductors feeding FEE. This coupling depends on the surface transfer impedance and surface transfer admittance of the shielded cable, which defines the quality and cost of the cable.

In this paper, the analysis of the propagation of the conducted noise through long cables and its effect in the system is presented. The balance among cable parameters, filters, and ground connection defines the effect on the FEE performance of common (CM) and differential mode (DM) noise generated by the power supplies. The influence of these parameters is studied using numerical simulation programs based on multi-conductor transmission line models whose parameters are extracted from real multi-conductor samples.

The CM and DM propagation as well as the cross-conversion between CM and DM conducted emissions are addressed in this study. This analysis is an example of an EMC-based design at early stages of the project.

II. MULTI-TRANSMISSION LINE MODEL

The studies are conducted using a cable model based on the multi-conductor transmission line (MTL) theory. This model assumes transverse electromagnetic (TEM) wave as propagation mode. It allows representing the cable in per-unit parameters that are relatively easy to measure or calculate given the geometry of the cable. A detailed analysis of MTL is presented in [1] [2] [3]. Based on the MTL theory, the multi-conductor cable can be modelled by the partial differential equation.

$$\begin{aligned} \frac{\partial}{\partial z} V(z, t) &= -R I(z, t) - L \frac{\partial}{\partial t} I(z, t) \\ \frac{\partial}{\partial z} I(z, t) &= -G V(z, t) - C \frac{\partial}{\partial t} V(z, t) \end{aligned} \quad (1)$$

where $I(z, t)$ and $V(z, t)$ are vectors representing the current and the voltage respect to the reference conductor, respectively; L , C , R , G , are the per-unit-length inductance, capacitance, resistance, and conductance $N \times N$ matrices, respectively, that contain the cross-sectional dimensions and properties of the line, z is the position along the transmission line and t denotes the time variable.

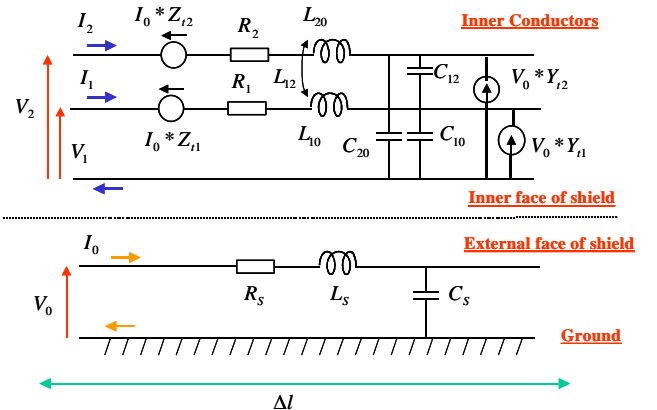

Figure 1: MTL – Shield model

The model presented above does not include the coupling effect in the central conductors of currents flowing through the shield. The equivalent circuit of fig.1 represents this coupling mechanism based on MTL theory for a sector of line of infinitesimal length [4]. The circuit consists of the inner system representing the central conductor of the shielded

cable and the braided shield as reference conductor. The outer system (shield - trays) is considered as a transmission line, where the metallic tray is the reference of the outer system and the shield is the conductor. The voltage and current sources at each inner conductor represent the interaction between both inner and outer systems. Z_t and Y_t represent the surface transfer impedance and the surface transfer admittance. The transfer impedance (Z_t) is defined as the ratio between the voltage of the inner conductor i respect to the shield and the current flowing through the shield, per unit length. The transfer admittance is defined as the ratio between the current flowing through the inner conductor and the voltage between the shield and the environment, per unit length. The last magnitude is generally very small and it has not been considered in the present study. Both, the surface transfer impedance and admittance are characteristic parameters of the shield of the cable.

The transfer impedance depends on three components as defined by the equation [5][6][7][8].

$$Z_t = Z_d(\omega) + j\omega.(Mh \pm Mb) \quad (2)$$

where: $Z_d(\omega)$: The Diffusion coupling component is due to skin effect in the shield. It is predominant at low frequencies.

Mh : The aperture-coupling component is defined as the coupling through the holes of the shield. It plays an important role in the value of the transfer impedance at high frequencies.

Mb : The braid inductance component is defined as the coupling between the external and the internal layers of the shield.

To include the effect of the surface transfer impedance and admittance in the inner conductors, the mathematical model defined by eqn. 1 is augmented by the generators $Z_t.I_o(z,t)$ and $Y_t.U_o(z,t)$.

$$\begin{aligned} \frac{\partial}{\partial z} V(z,t) &= -R I(z,t) - L \frac{\partial}{\partial t} I(z,t) + Z_t.I_o(z,t) \\ \frac{\partial}{\partial z} I(z,t) &= -G V(z,t) - C \frac{\partial}{\partial t} V(z,t) + Y_t.U_o(z,t) \end{aligned} \quad (3)$$

The solution of the complete system of equations starts with the solution of the outer system, calculating the distributed voltage $U_o(z,t)$ and the distributed current $I_o(z,t)$ at every location z of the outer system. These voltages and currents are used to calculate the magnitude of the additional generators defined in eqn. 3. After that, eqn. 3 is solved calculating the general solution of the MTL equation in frequency-domain and incorporating the terminal network constraints in the general solution to determine the line voltages and currents at the both ends of the line.

III. CM AND DM NOISE PROPAGATION IN POWER CABLES

The effects that electrically-long power cables introduces in the noise propagation has been addressed recently in the literature [9][10][11]. Some of those studies are focus on

predicting the effects introduced in the measurement of conductive noise, based on the EU standard, when the equipment under test is connected to the normalized impedance using a long cable. In the present analysis, the shielded twisted power cable of the HCAL sub-system has been chosen to study the effect of noise propagation in long power cables. In this part of the analysis, it is assumed that no current flows through the cable shield. The study is focused on the input/output transfer functions of a shielded twisted power cable of 15 meters long for different load conditions. .

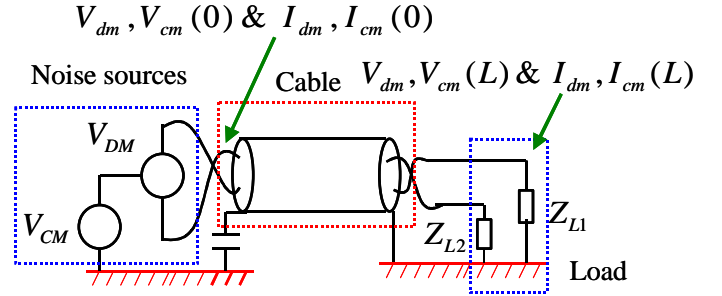

Figure 2: Circuit layout

The per-unit length parameter matrices for this power cable are measured at 1 MHz. The values of the inductance and capacitance per-unit length are:

$$L = \begin{bmatrix} 0.148 & 0.026 \\ 0.026 & 0.154 \end{bmatrix} \frac{\mu H}{m}; \quad C = \begin{bmatrix} 0.229 & -0.041 \\ -0.041 & 0.233 \end{bmatrix} \frac{nf}{m}$$

The cable model includes the skin effect in the central conductors and in the shield. This effect is analyzed more in detail in references [12]. The resistance matrix for the HCAL power cable is:

$$R = \begin{bmatrix} 0.0017 \cdot (1 + \sqrt{\frac{f}{5400}}) + 0.0035 \cdot (1 + \sqrt{\frac{f}{11000}}) & 0.0035 \cdot (1 + \sqrt{\frac{f}{11000}}) \\ 0.0035 \cdot (1 + \sqrt{\frac{f}{11000}}) & 0.0018 \cdot (1 + \sqrt{\frac{f}{5400}}) + 0.0035 \cdot (1 + \sqrt{\frac{f}{11000}}) \end{bmatrix} \frac{\Omega}{m}$$

Four load configurations have been chosen to study their influence in the noise propagation.

$$a) \quad Z_{L1} = Z_{L2} = Z_c$$

The load impedances are equal to the characteristic impedance of cable. For the analysis of the CM noise propagation, they are set equal to $Z_{c-cm}=30.4 \Omega$ and for the DM noise propagation, they are equal to $Z_{c-dm}=42.8/2 \Omega$. This case is unpractical for power distribution and it is included in the study as reference.

$$b) \quad Z_{L1} = 150 \Omega; \quad Z_{L2} = 150 \Omega$$

This case is chosen because 150Ω is used as normalized impedance for studies in CM propagation in cables.

$$c) \quad Z_{L1} = 150 \Omega; \quad Z_{L2} = 0 \Omega$$

$$d) \quad Z_{L1} = 150 \Omega \parallel 1\mu f; \quad Z_{L2} = 0 \Omega$$

These cases represent unbalanced loads. In this condition, one of the lines is directly connected to ground and the other is loaded with a resistor larger than the characteristic impedance of the cable. The case d) includes a capacitor in parallel with the 150 Ω resistor to simulate the effect of an input filter at the load-end.

This study is conducted decomposing the voltage and current per each conductor, at each position, in two orthogonal components. For currents, the common mode current is defined as $I_{cm}(z)=0.5(I_1(z)+I_2(z))$ and the differential mode current as $I_{dm}(z)=0.5(I_1(z)-I_2(z))$, where $I_1(z)$ and $I_2(z)$ are the current flowing through conductor 1 and 2 respectively at z position in the cable. Similar definition is used for voltages.

A. CM noise effects

To study the propagation of the common mode signals, based on the circuit depicted in fig. 2, the CM current transfer function is defined as:

$$T_{CM-I} = \frac{I_{cm}(L)}{I_{cm}(0)}$$

where $I_{cm}(0)$ and $I_{cm}(L)$ are the CM current at the sending-end and load-end of the cable. Fig. 3 shows the simulated results of the CM current transfer function for the four load configurations.

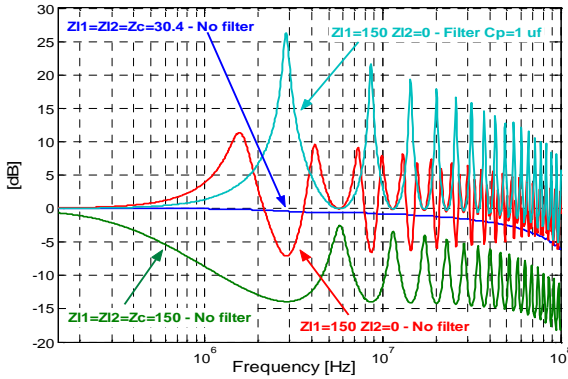

Figure 3: CM current transfer function.

For load resistors equal to the CM characteristic impedance of cable, the behaviour is similar to a low-pass filter where the attenuation is defined by the series resistance of the conductors. When the load is not matched, cable resonances are leading in the propagation of noise along the cable. For the balanced case and high impedance load, resonances are present however the CM current is attenuated when it propagates along the cable. On the other hand, when the load impedance is balanced and lower than the characteristic impedance, the cable starts amplifying the CM currents at the resonance frequencies. Similar case is present for unbalanced loads. In the case d) both loads are connected to ground through low impedances, the CM currents can be amplified up to 26 dB (20 times) at certain frequencies. This situation might happen if a RF capacitor is placed at the load in order to filter the noise of the line. This capacitor at high

frequency presents very low impedance to ground at the end of the line. This effect is important to take into account because the CM current flowing through the cables defines mainly the radiated emission of the cables.

The common mode voltage at the load-end is defined by the CM current and the load impedance. For case d) the CM voltage at the load is effectively attenuated by the load impedance while for the other cases, the CM voltage at the load is similar or larger than the CM mode voltage applied at the sending-end. To show this behaviour, the CM voltage transfer function, defined as

$$T_{CM-V} = \frac{V_{cm}(L)}{V_{cm}(0)}$$

is plotted for the different cases in fig. 4.

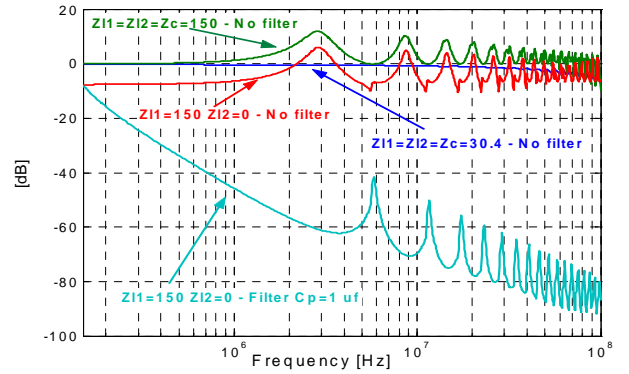

Figure 4: CM voltage transfer function.

Other important aspect in this analysis is the CM to DM conversion. This conversion is due to the load unbalance and also to the intrinsic minor unbalance of the cable. Fig. 5 shows the CM to DM current transfer function for the four configurations. This transfer function is defined as

$$T_{CM-I} = \frac{I_{dm}(L)}{I_{cm}(0)}$$

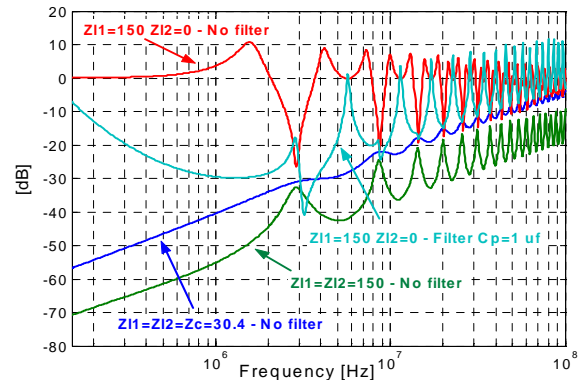

Figure 5: CM to DM current transfer function

For balanced loads (cases a) and b)), the CM to DM conversion exists due to the unbalances in the cable parameters, which are dominated by the mismatch of the cable inductance. From fig. 5, it is possible to observe that

this effect is important only at very high frequencies. For the case of unbalanced loads, the conversion now is settled by the load and at some resonant frequencies the conversion mode have a gain of 10dB or more.

Similarly to the previous case, the differential voltage across the load terminals induced by CM currents at the sending-end can be estimated by the DM currents at the load and its impedance. For case d) the DM voltage is effectively attenuated by the load impedance.

B. DM noise effects

The DM current transfer function of the circuit is defined as:

$$T_{DM-I} = \frac{I_{dm}(L)}{I_{dm}(0)}$$

Fig. 6 shows the DM current transfer function for the four load configurations mentioned before.

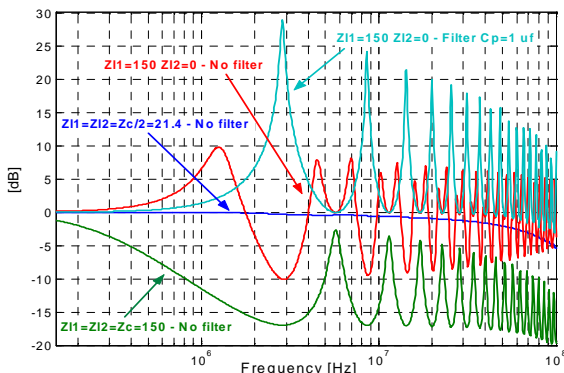

Figure 6: DM current transfer function

Again, the resonant frequencies are only attenuated for values equal to the DM characteristic impedance of cable, being amplified for low impedances values. These results are very similar to the ones for the CM current transfer function. However, their implications are not as important as in the CM currents because the DM current ability to radiate is much lower than the CM currents and also the FEE is more sensitive to CM perturbations flowing through the power cables than DM perturbations [13].

The DM voltage, DM to CM current and DM to CM voltage transfer functions present similar results to the one analysed CM signals. There only small differences in amplitude and resonant frequencies. Basically both configurations are the same with the only difference given by the CM and DM impedances.

C. CM and DM effects - Global analysis -

The study presented above assuming different impedances at the load-end of the cable shows that both CM/DM currents and voltage can be amplified by the cable resonance when they propagate from the sending-end to the load-end. The only case where there not exist resonances that amplifies the transmitted signals is when the load impedance matches the

characteristic impedance of the cable. This case, for power distribution, is unpractical.

High impedance, balanced loads attenuate the CM and DM currents transmitted through the cable, but the CM and DM voltage across the load terminals is amplified. On the other way, low impedance and balanced loads amplify the CM and DM currents at the resonance frequencies.

Unbalanced loads are typical in high-energy physics. The return plane of the FEE is, in general, connected to ground to minimize the voltage variations across the parasitic capacitances between the shielding box and the sensitive inputs of the amplifiers. This connection implies in general, that the return power cable is connected to ground. From this study it is shown that for unbalanced loads, both the CM and DM mode signal are amplified at the resonance frequencies of the cable. In particular, when a capacitor filter is included across the load terminals, the CM and DM currents flowing through the cable are amplified, but the DM and CM voltage across the load terminals are effectively attenuated. This configuration reduces the noise current coupled to the resistive part of the load by-passing those currents through the capacitor. This behaviour explains a typical EMC-based design rule, which is to put the by-pass filter capacitor of the input power filter as close as possible to the entrance point of the power cable [2]. This filter limits both the DM and CM voltage at the input but amplifies both the CM and DM currents flowing through the cables. If the filter is placed close to the sensitive electronics into the screened box or cabinet, the power cable running inside the box, from the entrance point to the filter, radiates and could interfere with the FEE.

The current levels produced by the amplification of the CM and DM currents for the case of unbalanced loads with capacitor filter can generate unwanted electromagnetic radiation from the cable. The radiation efficiency of a cable is proportional to the loop area of the current path. For differential mode currents, the effective area is minimum if the both conductors, active and return, are adjacent each other or are twisted. For CM currents, the return path is not always perfectly defined. In the present analysis, it is assumed the CM current return through the internal part of the shield and, in this case, the effective area is ideally zero. If the cable has not shield, this analysis is still valid if it is possible to assume transverse electromagnetic wave as dominant propagation mode [3]. In this case, the return path is not completely defined by the cable itself but it is defined by the position of the cable respect to the reference structure and the effective radiation area can be large. It is critical for cables without shield to reduce the level of CM current to avoid unwanted electromagnetic radiation.

IV. CM & DM NOISE PROPAGATION IN A POWER SUPPLY DISTRIBUTION SYSTEM FOR HIGH ENERGY PHYSICS

The propagation of the noise generated by power supplies (PS) and the noise generated by ground currents are studied

for the power supply distribution of the HCAL sub-system. In this sub-system, the nominal low voltages at the FEE input power are 6.5V and 5V and internal linear regulators convert those values to 5V, 3.3V and 2.5V. The power supply units and the FEE are connected by shielded twisted-pair cables, whose length is between 15 and 20 meters.

In this analysis, the model is composed by three blocks: the PS unit and EMI filter, the cable and the FEE, as it is depicted in fig. 7. The PS unit and EMI filter are represented by the combination of two current generators (CM and DM) and output capacitors. These sources represent the emissions generated by a DC-DC converter. Power supplies are connected to the FEE through a 15 meters long cable (external diameter of 12 mm), placed 10 mm above a metallic tray. The FEE input power is represented by a reduced model composed by a set of real capacitors in parallel with 1 MΩ resistance. The input impedance of this network is modelled, at low frequency, by high impedance and at high frequency by very low constant impedance. Additionally, in the present model it is assumed there exists a voltage difference (V_{Gnd}) between the PS ground and the FEE ground connections. This voltage V_{Gnd} generates a current through the external part of the shield that couples noise to the internal conductors of the cable through the surface transference impedance. The quality of shield defines the amount of noise coupled to the central conductors. The performance of two cables with different shield is studied.

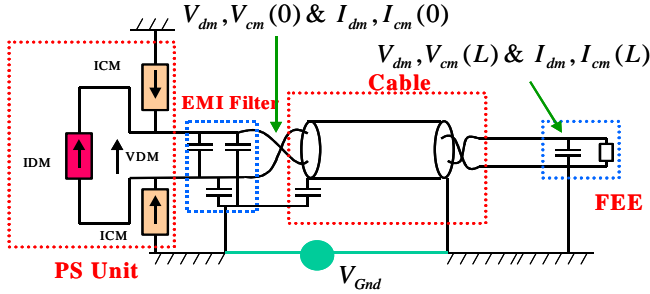

Figure 7: Test layout

A. Power supply noise currents

The effect of the cable on the CM signal transmitted is quantified by the CM current transference and the CM voltage transference. These quantities are defined as

$$T_{CM-I} = \frac{I_{cm}(L)}{I_{cm}(0)} \quad \& \quad T_{CM-V} = \frac{V_{cm}(L)}{V_{cm}(0)}$$

Fig. 8 shows these transfer function, where the left vertical axis measures the CM voltage gain and the right vertical axis indicates the CM current gain.

The low impedance presented by the FEE at high frequency, amplifies the CM currents at the resonance frequencies but effectively attenuates the CM voltage at the input terminals. Based on these results, a combination of three factors is necessary to take into account during the design to reject the direct effect of CM currents generated by power supplies. First, a low level of CM emission at the output of the power supply should be

specified. Second, use a power cable with screen to limit the radiation of the long cable and finally select an appropriated CM filter. The location of this filter is very critical, being the best spot as close as possible to the entrance of the power cable into the shielding cabinet or box.

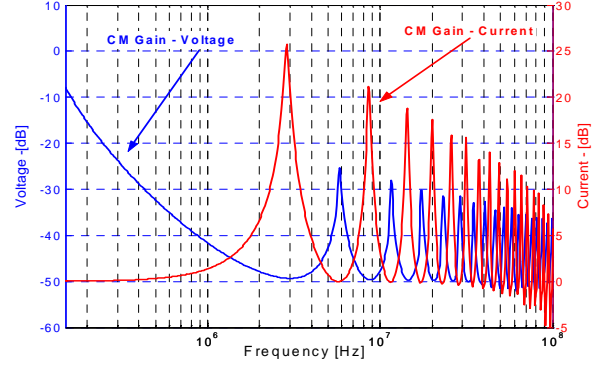

Figure 8: CM to CM transfer functions

It is important to analyse the cross-effect from DM to CM because the front-end electronics is more sensitive to CM perturbations in the power cables than DM perturbations. The DM-CM transfer functions are defined as

$$T_{DM/CM-I} = \frac{I_{cm}(L)}{I_{dm}(0)} \quad \& \quad T_{DM/CM-V} = \frac{V_{cm}(L)}{V_{dm}(0)}$$

Fig. 9 shows the transfer function for both voltage and current.

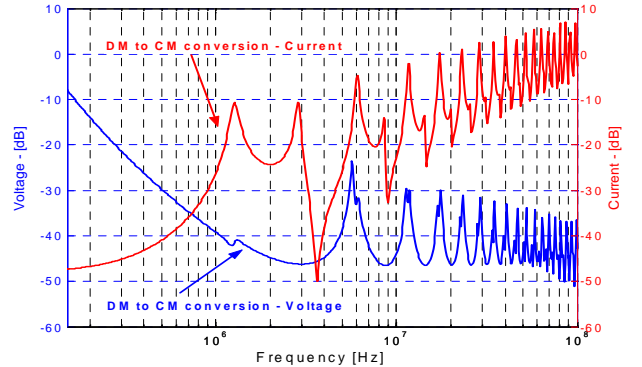

Figure 9: DM to CM transfer function

The current transfer function increases with the frequency. This effect is generated by the unbalances of cable at high frequency. On the other hand the voltage TF decreases with the frequency because the input filter of the FEE presents very low impedance reducing the noise voltage at the input terminals.

B. Ground currents

In the study of the ground currents, mainly two cables with different shields are compared to show the difference between a cable whose screen is built with an aluminium sheet and a cable whose shield is cooper braid. The magnitude used to quantify the ratio between the CM current at the load and the ground voltage is the admittance

$$Y_{CM} = \frac{I_{cm}(L)}{V_{Gnd}}$$

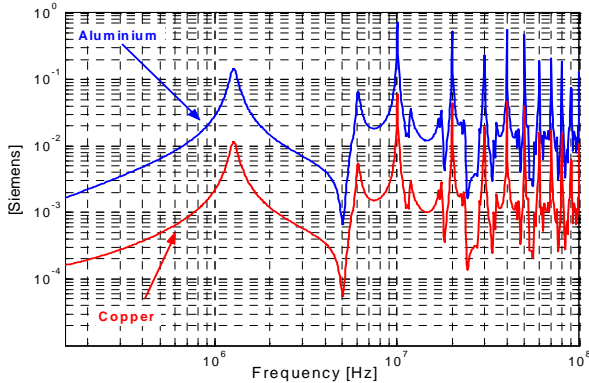

Figure 10: CM admittance

Fig. 10 shows the admittance between the ground voltage and CM current for a cable with different shields. At low frequencies, the amount of CM coupled increases because the transfer impedance increases and the external current is constant. At high frequencies, the cable resonance amplifies the coupled noise. The important point in this analysis is to show the difference in the amount of noise coupled when different screens are used to manufacture the cable.

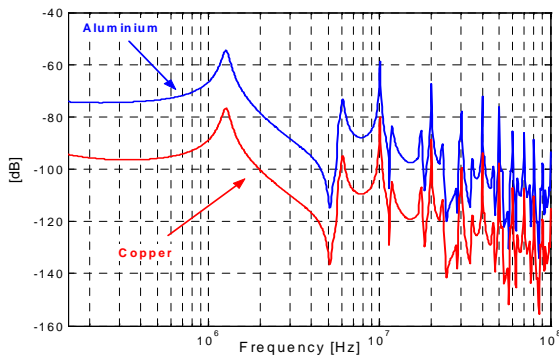

Figure 11: DM mode transfer function

Similarly, it is possible to quantify the ratio between the DM voltage at the input power terminals and the ground voltage by the transfer function

$$T_{DM} = \frac{V_{dm}(L)}{V_{Gnd}}$$

It is depicted in fig. 11. The quality of the shield is very important to define the amount of noise that can be coupled to the central conductors. The value of transfer function decreases at high frequency due to the capacitor at the input of the FEE.

V. CONCLUSIONS

This paper addresses the effect of long cables on the noise propagation between the power supply units and the FEE. CM

and DM noise currents flowing into the input power terminals of the FEE degrades the noise performance of the sensitive electronics. To avoid that these currents flow into the FEE, CM/DM filters have to be placed at the power entrance. Input filters balance the load presented to the cable at high frequency, which is effective to decrease the CM to DM and DM to CM conversion. However, these filters amplify the CM currents flowing through the cable and it can radiate severely. To attenuate this effect, power supplies have to exhibit, at the output, a low level of conducted CM emission and the cables have to present shielding.

VI. REFERENCES

- [1] A. R. Djordjevic, T. K. Sarkar and R. F. Harrington" *Time domain Response of Multi-conductor Transmission Lines*", Proc. IEEE 1987, Vol 75 pp.743 – 763
- [2] C.R. Paul, *Introduction to Electromagnetic Compatibility* NY: Wiley-Interscience, 1992, ISBN-0-471-54927-4
- [3] C.R. Paul." *Analysis of multi-conductor transmission lines* ", 1992, ISBN-0-471-02080-X
- [4] Lorenz-Jung, Jan Luiken ter Haseborg " *Evaluation of measured complex transfer admittance for the characterization of shield in-homogeneities of Multi-conductor Cables* ", IEEE Trans. on Electromagnetic Compatibility vol. 41 No 4 - Nov.1999
- [5] Edward F. Vance " *Coupling to shielded cables* ", 1987, ISBN 0-89874-949-2.
- [6] Goedbloed, Jasper J. " *Electromagnetic Compatibility* ", 1990, ISBN-0-13-249293-8.
- [7] Tyni M. " *The transfer impedance of coaxial with braided outer conductor* ", Pr. Nauk, Inst Telekomun Akust. Politech Wroclaw Ser. Konfi pp 410-419, 1975.
- [8] S.Sali, " *An improve Model for the Transfer Impedance Calculations of Braided Coaxial Cables* " IEEE Trans. on Electromagnetic Compatibility vol. 33 No 2 - Nov.1991.
- [9] Sergio A. Pignari, A. Orlandi" *Long-Cable effects on conducted emissions levels* ", IEEE Transactions on Electromagnetic Compatibility, vol. 45, No 1, Feb. 2003.
- [10] S. Canigia, F. Maradei, " *Equivalent circuit models for the analysis of coaxial cables immunity* ". Proc. IEEE Int. Symp. on Electromagnetic Compatibility, August 2003.
- [11] A. Orlandi " *Frequency and time domain modeling of the transfer impedance and distributed longitudinal induced voltage by means of a Spice equivalent circuit* ", IEEE Trans. on Electromagnetic Compatibility, Vol. 45 No 1, Feb. 2003.
- [12] Ashok K. Agrawal , Harold J. Price, Shyam H. Gurbaxami " *Transient Response of Multi-conductor Transmission Lines Excited by Non-uniform Electromagnetic Fields* ", IEEE Trans. on Electromagnetic Compatibility Vol. 22 No 2 - May.1980.
- [13] F. Artech, C. Rivetta, F. Szoncsó " *EMC immunity test results of HCAL FEE* " Proc. 9th Workshop on Electronics for LHC experiments, LECC2003. Amsterdam, October 2003.